

Description

LPK is a range of compact in line duct fans. They benefit from very low profiles. The LPK 200 is only 20 mm higher than the duct diameter. This makes the LPK range an ideal choice where a low installed height is required. All fans are fitted with an external rotor motor whose bearings are sealed for life and a forward curved impeller for high performance and a very low sound level. Cleaning and maintenance are made easy with the swing out motor and impeller assembly.



Technical data

Parameter	Value	Unit
Voltage	230	V
Phase	1	~
Frequency	50	Hz
Power	0.05	kW
Current	0.21	A
R.p.m.	1050	r/m
Max. temperature of transported air	80	°C
Max. temperature of transported air when speed-controlled	80	°C
Sound pressure level at 3 m	42	dB(A)
Length	350	mm
Width	272	mm
Height	152	mm
Weight	3.8	kg
Enclosure class, motor	44	IP
Insulation class, motor	F	
Capacitor	4	µF
Duct connection	ø125 mm	

Diagrams

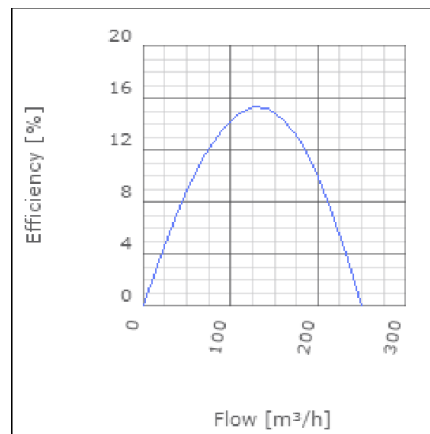
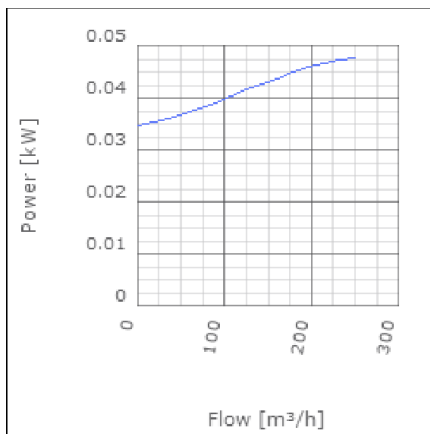
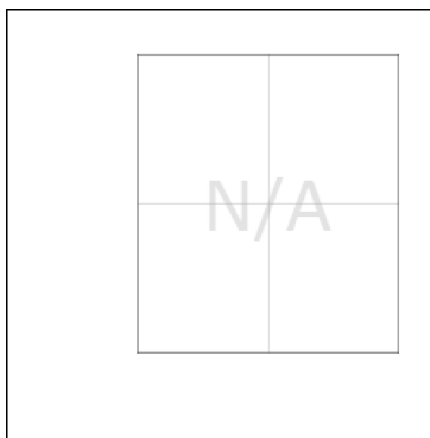
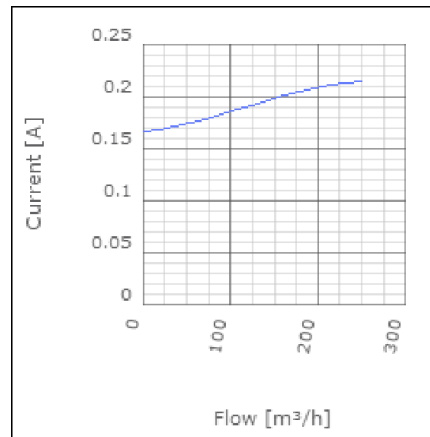
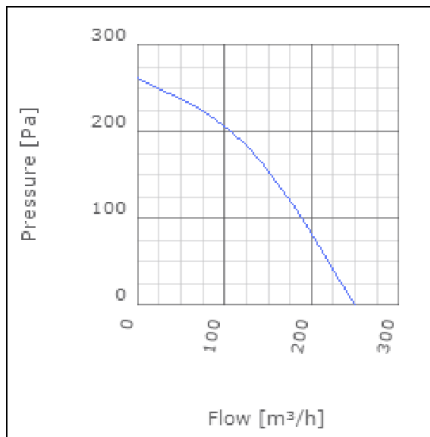

Sound

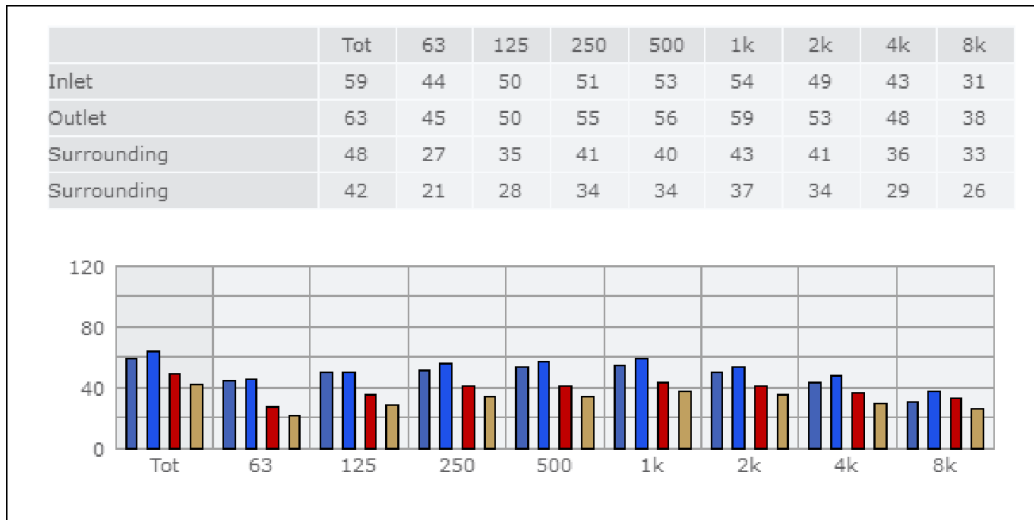

Parameter

Distance: 3.000
 Propagation type: Hemi-spherical
 Equivalent absorption area: 20.00

Checked point

Flow 167.266m³/h
 Static pressure 128Pa

Working point

Flow 168.996m³/h
 Static Pressure 130Pa
 Power 0.04kW
 Speed 0r/m
 Current 0.2A
 Voltage 230V
 Efficiency 13.75%
 SFP 0kW/m³/s

Dimensions

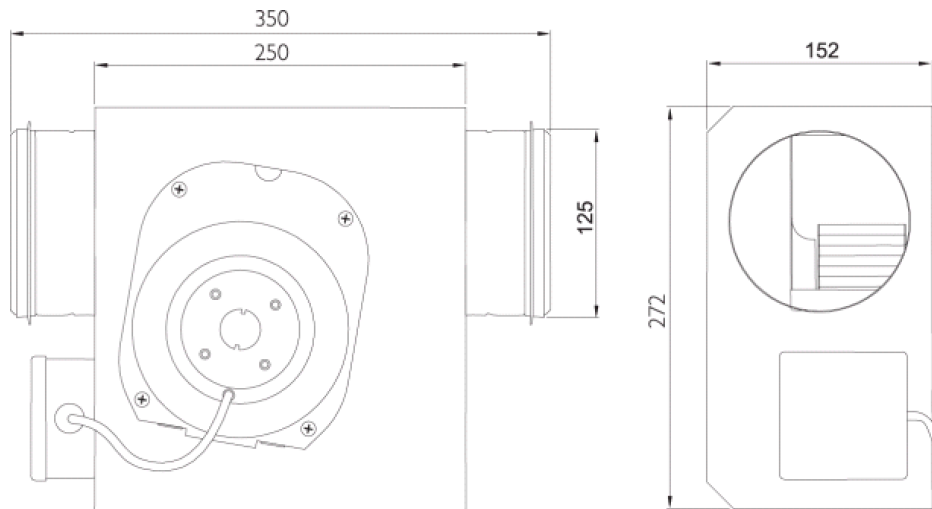

Wiring diagram

4040002

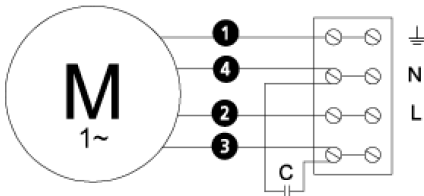

- Ⓜ = Fan Motor
- Ⓜ1 = Fan Motor
- Ⓜ2 = Fan Motor
- Ⓜ3 = Rotor Motor
- ① = Yellow/Green
- ② = Black
- ③ = Blue
- ④ = Brown
- ⑤ = White (TW)
- ⑥ = Orange
- ⑦ = Grey
- ⑧ = Red
- ⑨ = Green
- ⑩ = Violet

Accessories

ETFV-94A
FRE 6
VRDE 1,5
VRS 0,5
VRTEC

Electrical accessories

FLF 125
FLK 125
BSV 125
YG 125
LDC 125